

**RTD sensor
with plug-in connection head and at
resistive element**

TM 12 50 / TM 12 D 50

Temperature sensor with or without compression fitting et stainless steel contact tip.
 Measuring range (according to reference) : **from -80°C to +400°C** (PT100 and PT1000).
from -20°C to +120°C (NTC)
 Mounting of wires : **simple** (2, 3 or 4 wires).
multipair (4, 6 or 8 wires).
 For other resistor types PT25, PT50, PT500, PT200 or NI, please contact us.



Plug-in head

Part numbers

To order, just add the codes to complete part number.

TM 12

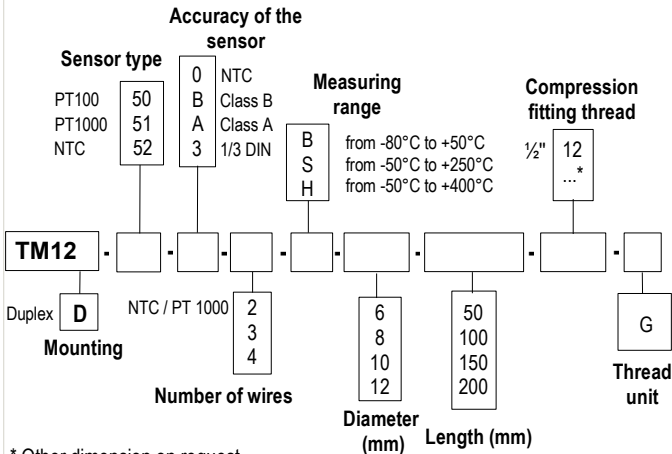

* Other dimension on request

Example : TM12-50-B-3-8-S-100-12G.

Model : PT 100 temperature sensor class B, 3 wires with 8 mm diameter and length with thread of 100 mm. With compression fitting 1/2" G.
 Measuring range **from -50°C to 250°C.**

TM 12 D

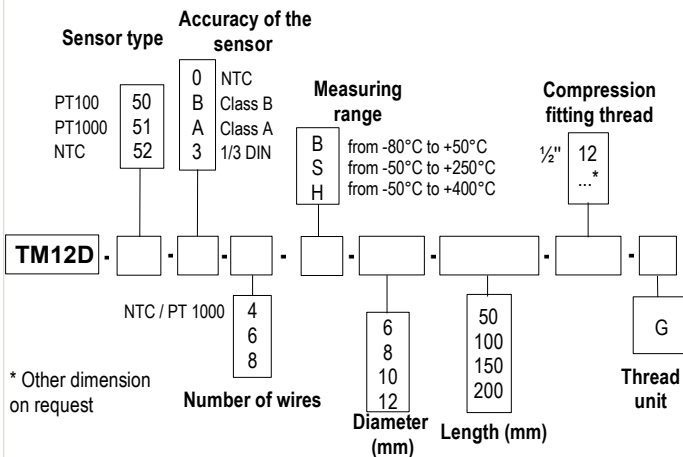

* Other dimension on request

Example : TM12D-50-B-6-S-8-100-12G.

Model : PT 100 temperature sensor class B, multipair mounting, 6 wires with 8 mm diameter and length with thread of 100 mm. With compression fitting 1/2" G. Measuring range **from -50°C to 250°C.**

Technical features

Operating temperatures.....from -80°C to +400°C (PT100 and PT1000)
 (according to reference) from -20°C to +120°C (NTC)
Accuracy.....PT100 or PT1000 : see "Tolerances" table
 NTC : see "Tolerances" table
Sensor type.....PT100 or PT1000 : Class B, Class A,
 1/3 DIN as per DIN IEC 751
 NTC: resistance at 25°C, R₂₅ = 10KΩ
 Nominal Beta value B25/85 = 3,695K ±1%

Mounting of wire.....single pair 2, 3 or 4 wires
 For T>250°C do not use 4 wires in a sheath of 6mm Ø.
multipair 4, 6 or 8 wires
 8 wires mounting from 8 mm.



Storage temperature.....from -20°C to +80°C
Contact tip.....316 L stainless steel, without welding, from 3/4 to 4/4 hard
 Other on request
Compression fitting.....316 L stainless steel
Thread.....with or without, 1/2" G in standard
 Other on request
Electrical connection.....shielded PVC cord of 2 metres
 knurled head screw
 Protection : IP 67 only for a screwed state
 Contact : nickered CuZm with gilding of 0.8 µm
Adjustable mountings.....flange, offset fitting, perforated, etc...

■ Dimensions

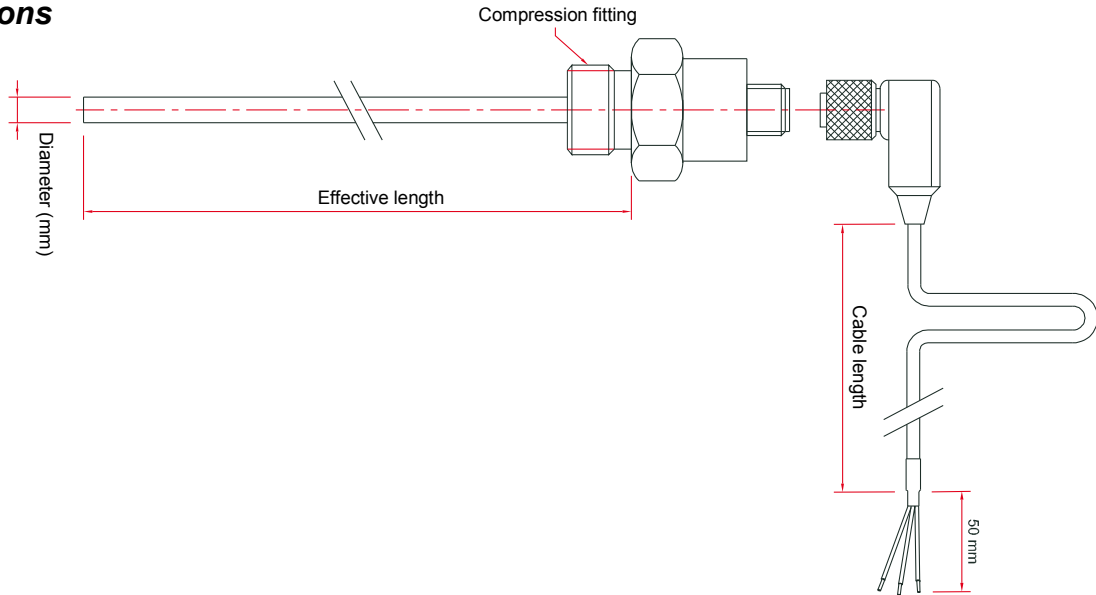

■ Useful information on thermometry with platinum resistor PT100.

2-wire connection

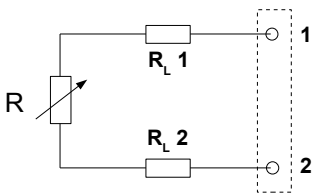

This is the simplest way, but line resistors (RL1 and RL2) are connected to the sensor in a series circuit. The addition of RL1 + RL2, leads to an off-set between measured temperature and real temperature. This connection must be avoided.

3-wire connection

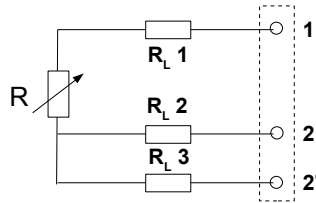

This connection involves identical line resistors (RL1-RL2-RL3), RL2 + RL3 allow you to measure the line resistance that will be subtracted from the measured resistance between 1 and 22' terminals. This is the most common connection.

4-wire connection

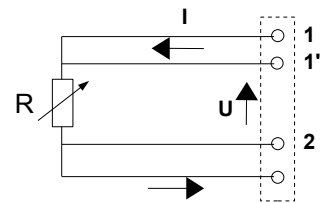

Regulated current is going through 11' and 22' terminals and the measurement is made at the sensor terminals, so none of the line resistors are taken into account. This is the most accurate connection.

■ Tolerances* of NTC probes

Measuring range °C	Tolerances °C
from -20°C to 0°C	± 0,5°C
from 0°C to +70°C	± 0,2 °C
from +70°C to +100°C	± 0,5 °C

*all accuracies indicated in this technical data sheet were stated in laboratory conditions, and can be guaranteed for measurements carried out in the same conditions, or carried out with calibration compensation.

■ Tolerance* of PT100 and PT1000 probes.

Norm as per IEC 751 (1993).

Temp °C	Tolerances					
	Class B		Class A		1/3 DIN	
	± °C	± Ohms	± °C	± Ohms	± °C	± Ohms
-100	0.8	0.32	0.35	0.14	0.27	0.11
-50	0.55	0.22	0.25	0.1	0.19	0.08
0	0.3	0.12	0.15	0.06	0.1	0.04
100	0.8	0.3	0.35	0.13	0.27	0.1
200	1.3	0.48	0.55	0.2	0.44	0.16
300	1.8	0.64	0.75	0.27	0.6	0.21
400	2.3	0.79	0.95	0.33	0.77	0.26

Resistance values for PT1000 (Ω) must be multiplied by 10 for the same corresponding temperature value (°C). I.e : at 0°C for Class B PT1000 ± 0.3°C → ± 1.2 Ω

■ Accessories (See data sheet)

Transmitter output 4/20 mA or 0/10V

Wall fixing support

Stainless steel mounting brackets

¼" or ½" Gas screw nut

Stainless steel compression fitting

Teflon or stainless steel ferrule for compression fittings

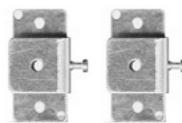

Sleeve to weld for food industry

Stainless steel union fitting

½" Gas or NPT thread cuff

Thermo-conducting silicone grease

Calibration certificate

Thermowell

