

REFERENCES AND VERSIONS

References

4-20mA OUTPUT

0103011001	Anemo4403 V3 4-20mA OUTPUT 120 km/h M8 LATERAL
0103011002	Anemo4403 V3 4-20mA OUTPUT 180 km/h M8 LATERAL
0103011003	Anemo4403 V3 4-20mA OUTPUT 120 km/h 20m CABLE
0103011004	Anemo4403 V3 4-20mA OUTPUT 180 km/h 20m CABLE
0103011005	Anemo4403 V3 4-20mA OUTPUT 120 km/h TIME 2s 20m CABLE

0-10V OUTPUT

0103010901	ANEMO4403 V3 0-10V OUTPUT 120km/h 20m CABLE
0103010902	ANEMO4403 V3 0-10V OUTPUT 180km/h 20m CABLE

Other devices of ANEMO4403 V3 range

Heated 4-20 mA

0103011401	ANEMO5H25 V3 4-20mA OUTPUT 120km/h M12 UNDERSIDE NO FEMALE CONNECTOR
0103011402	ANEMO5H25 V3 4-20mA OUTPUT 120km/h M12 UNDERSIDE
0103011403	ANEMO5H25 V3 4-20mA OUTPUT 120km/h M12 UNDERSIDE 12m CABLE
0103011404	ANEMO5H25 V3 4-20mA OUTPUT 120km/h M12 UNDERSIDE 25m CABLE
0103011405	ANEMO5H25 V3 4-20mA OUTPUT 180km/h M12 UNDERSIDE NO FEMALE CONNECTOR
0103011406	ANEMO5H25 V3 4-20mA OUTPUT 180km/h M12 UNDERSIDE
0103011407	ANEMO5H25 V3 4-20mA OUTPUT 180km/h M12 UNDERSIDE 12m CABLE
0103011408	ANEMO5H25 V3 4-20mA OUTPUT 180km/h M12 UNDERSIDE 25m CABLE

Displays

0106030411	WM44-EV011 V3 IP65 24Vdc*
0106030412	WM44-EV011 V3 IP65 230Vac*
0106030901	WM44-P V3 AI 0-10V/4-20 mA INPUT 24Vdc
0106030902	WM44-P V3 AI 0-10V/4-20 mA INPUT 230Vac
0001	V-12
0103024473	BS100/3 4-20mA (multifunction display large size 3 digitis)
0103024474	BS100/4 4-20mA (multifunction display large size 4 digitis)
0103024475	BS100/5 4-20mA (multifunction display large size 5 digitis)

*Only for 4-20mA OUTPUT version

Accessories

0103010505	Stainless steel bracket AISI 304
0103010506 ¹	Stainless steel bracket plus hardware for mounting the wind sensor on the bucket
0103010507 ¹	Magnets for flat ferromagnetic surfaces. This fixation system can support up to 90 kg
0103010508	2 steel clamps kit that can be fixed to irregular parts measuring up to 63 x 45 mm

¹ 10 unit minimum order. On sale exclusively with wind sensor.

*For other references, please contact us.

NUOVACEVA
AUTOMATION



ANEMO4403 V3 0-10V OUTPUT ANEMO4403 V3 4-20mA OUTPUT

ANEMO4403 V3

Wind speed sensor designed for different industries and sectors.

ANEMO4403 V3 ANALOGUE OUTPUT is an analogue output anemometer, with 0-10V and 4-20mA versions. Output proportional to the wind speed with a full scale of 120 km/h or 180 km/h.

Industrial design for extreme environments

Analogue output (4-20 mA or 0-10 V)

Stainless Steel bearings

Low consumption

NUOVACEVA
AUTOMATION

NUOVA CEVA AUTOMATION S.R.L.
via Don Signini 43 - 28010 - Briga Novarese - NO - ITALY
Phone +39 0322 93574

info@nuovaceva.it www.nuovaceva.it

CE

APPLICATIONS

ANEMO4403 V3 has been designed for industrial applications: cranes, solar panels, wind turbines, weather stations... It is usually connected to devices such as displays (see our references WM44- EVO11, V12, BS100/X, WM44- P AI), PLCs or dataloggers to display the wind speed and/or set alarms to predefined values or to obtain records during predefined periods of time. The wind sensor must be fixed on a vertical position.

WIND SPEED - OUTPUT RATIO

Output signal proportional to the wind speed.

4...20 mA = 0...120 km/h

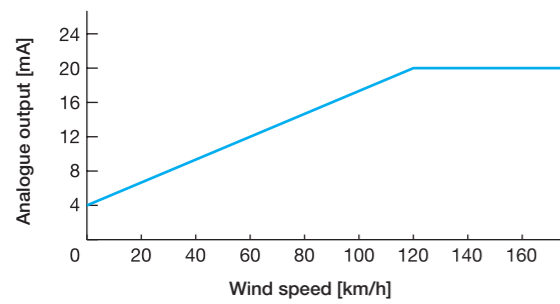

4...20 mA = 0...180 km/h

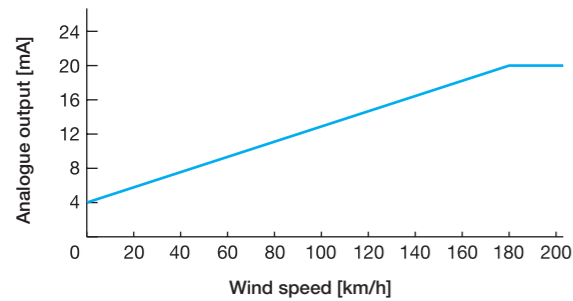

0...10 V = 0...120 km/h

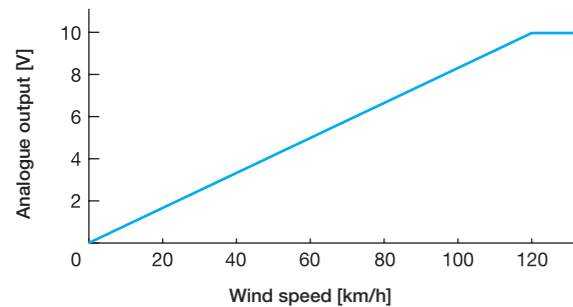

DIMENSIONS

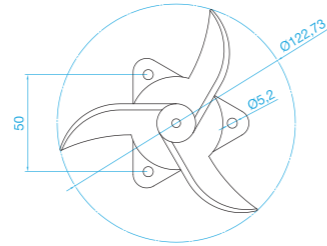

ANEMO4403 V3 CABLE

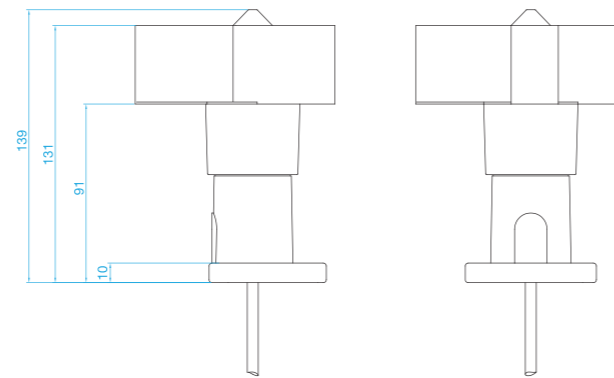

ANEMO4403 V3 M8 LATERAL

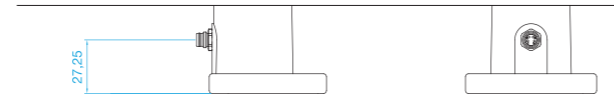

0...10 V = 0...180 km/h

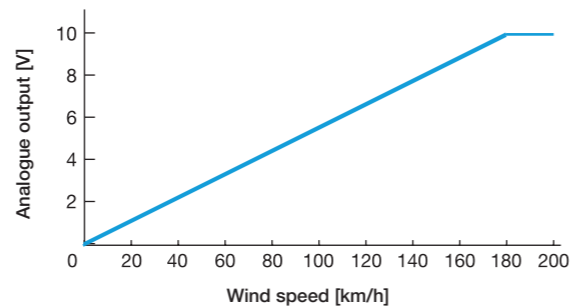

TECHNICAL FEATURES

4-20 mA OUTPUT Electrical features

Power supply	12...30 Vdc
Maximum current	<20 mA
Type of output	Analogue (4-20 mA, 2 wires)
Maximum connectable impedance	$R_L < \frac{V_{cc} - 8V}{0.02 A} \Omega$

0-10 V OUTPUT Electrical features

Power supply	15-24 Vdc
Power consumption	<2.5 W
Type of output	Analogue (0-10 V)
Minimum connectable impedance	4k6 Ω

Measurements

Range	3-120 km/h* 3-180 km/h*
Starting speed	8 km/h
Survival speed	200 km/h
Accuracy	1km/h (3-15 km/h) 3% (15-120 km/h)* 3% (15-180 km/h)*

*Depending on version

General features

Material	PA + FV
Bearings	Stainless steel X65Cr13
Type of connection	See references
Weight (with a 20m cable)	1425 g
Weight (without cable)	135 g
Dimensions	125x139 mm
Storage temperature	-35°C +80°C
Working temperature	-20°C +70°C
EMC	EN 61000-6-2:2001 EN 55022:2001, Class B
Protection	IP65 (UNE 20324:1993)

CONNECTION

ANEMO4403 V3 4-20 mA OUTPUT

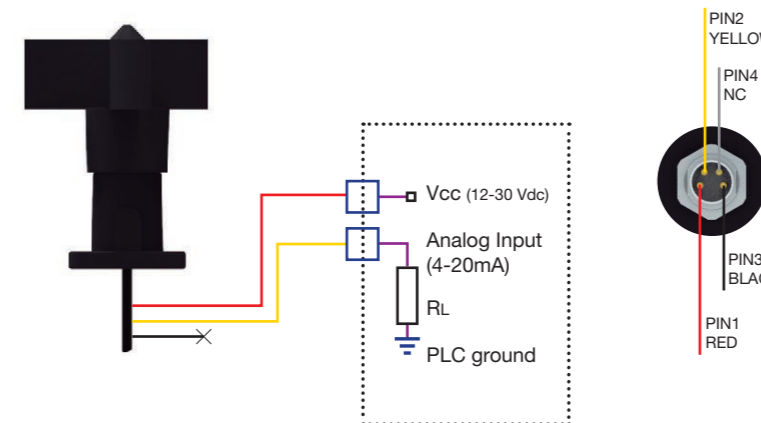

ANEMO4403 V3 0-10 V OUTPUT

